



48(51.2)V LiFePO4
 **150Ah**

Cabinet Type
Wall Mounted Type



Please Read The Manual Carefully Before Using The Equipment.

Cloud Energy 51.2V 150Ah Cabinet Type Lithium LiFePO4 Deep Cycle Rechargeable Battery

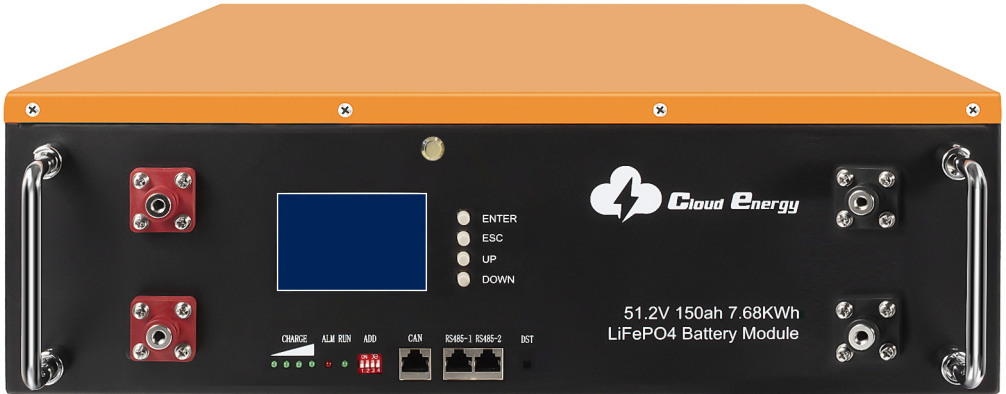

Cloud Energy 51.2V 150Ah Wall Mounted Lithium LiFePO4 Deep Cycle Rechargeable Battery

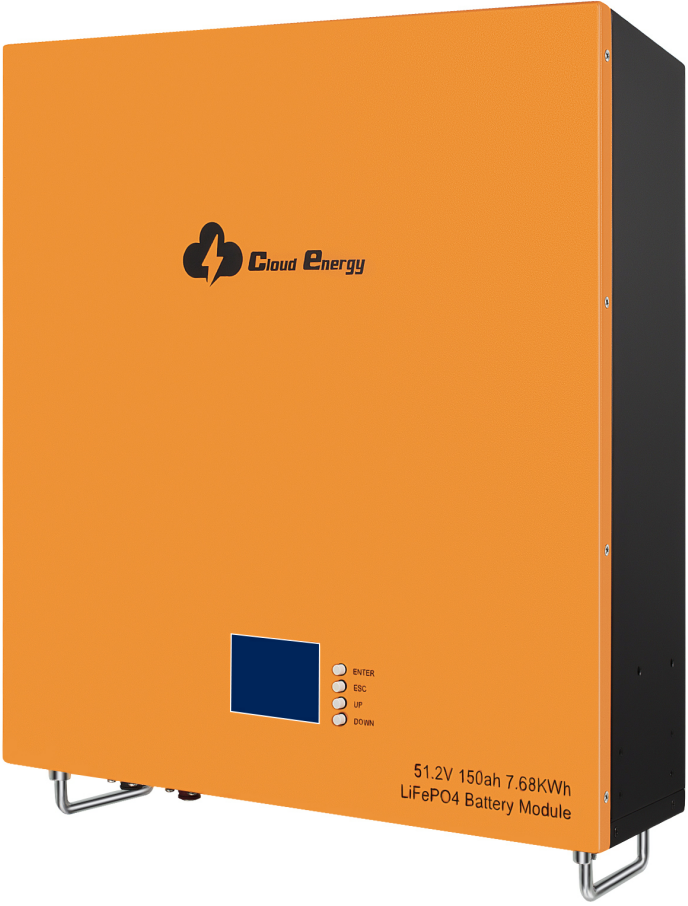

The instructions can be used uniformly for both batteries, and the installation methods are different.

PRODUCT OVERVIEW

BATTERY

Combination: 51.2V150Ah

Dimension: L18.9*W17.64*H6.3 inch

Metal Case Color: Orange+Black



TERMINAL & POST BOLTS

Terminal Size:

M8 (1.25mm Metric Thread)

Post Bolts:

M8 (1.25mm Metric Thread * 14mm Bolt Length)

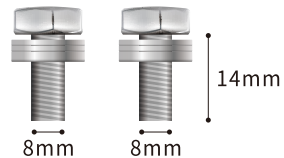

(The bolts can be replaced with M8 bolts of other lengths based on actual needs.)

GENERAL INFORMATION

Operating Voltage: 51.2V

Charging Voltage: 58.4±0.75V

Max Continuous Load Power: 5120W

Max Continuous Charge/ Discharge Current: 100A

NOTICE BEFORE USING

Step
1

CONTACT US at info@cloudnewenergy.com to activate the FIVE-YEAR WARRANTY

Step
2

PULL OUT Packaging box.

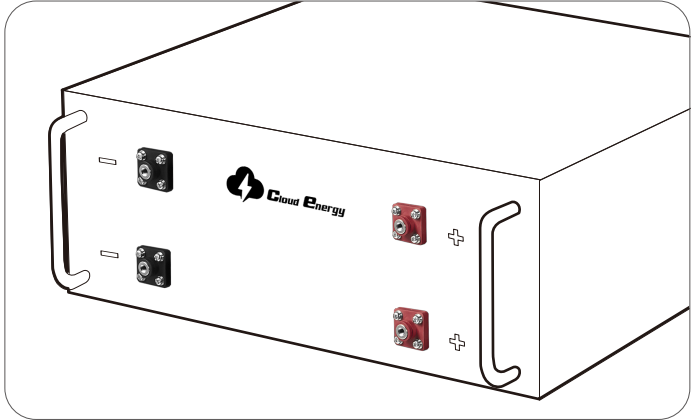

Step
3

TEST The Battery Voltage with Multimeter

>48v To step 4

<48V Contact us at info@cloudnewenergy.com to help solve the problem

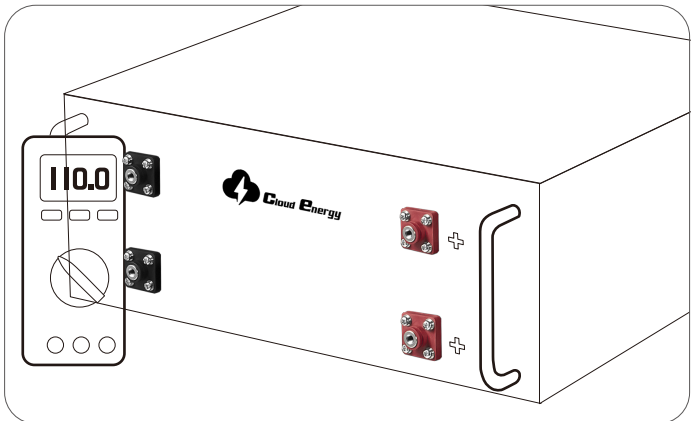



Step
4

FULLY CHARGE The Battery Separately

(Refer to Page 04 for battery charging methods)

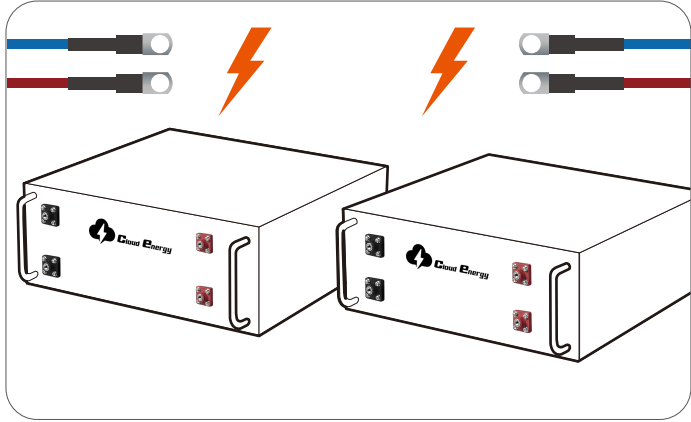

Step
5

CONNECT To Use

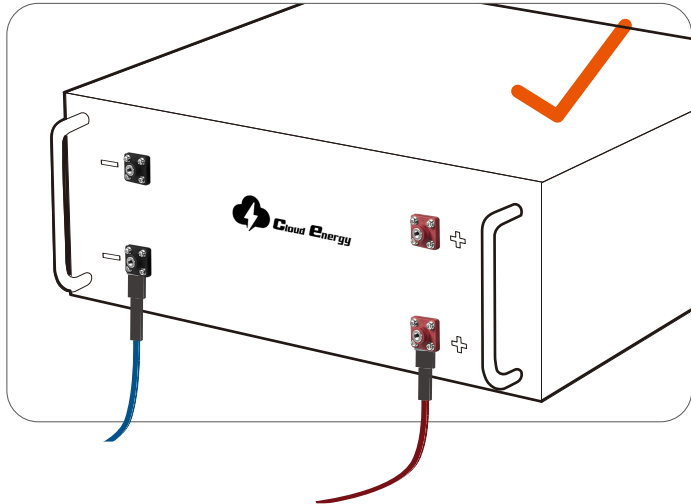



CONTENTS

BATTERY PARAMETERS

page

01

THINGS TO KNOW BEFORE USING

page

03

Long Term Storage

03

CHARGING METHODS

page

04

Background
Information

The Voltage When Charging & Discharging

04

Battery Charging Logic

05

LiFePO4 Battery Charging Mode

Lead Acid Battery Charging Mode

Method I

Solar Panel(s) & Controller

07

Solar Panel

Controller

Controller Settings

Method II

Battery Charger

08

Method III

Alternator / Generator

08

HOW TO ESTIMATE THE BATTERY CAPACITY	page
	09
State of Charge (SOC)	09

PARALLEL CONNECTION	page
	10
The Premise of Connection	10
Limitation for Series/Parallel Connection	10
How to Connect Batteries	11
Accessory Recommendation	
Step 1 Wear Insulating Gloves	
Step 2 Voltage Balancing Before Connection	
Step 3 Total Input & Output Connection	
Step 4 Rebalancing Every Six Months	

INVERTER SETTINGS	page
	16

WHAT TO DO WHEN THE BATTERY STOPS WORKING?	page
	17

BATTERY-PACK MAIN PARAMETERS

Cell	Prismatic LiFePO4 Battery
Nominal Capacity	150Ah
Usable Capacity	150Ah
Nominal Voltage	51.2V
Energy	7680Wh
Charge Method	CC / CV
Charge Voltage	58V±0.75V
Recommend Charge Current	45A (0.3C)

Battery Management System (BMS) Board	100A
Max. Continuous Charge / Discharge Current ^①	110A
Max. Discharge Current 5 Seconds	120A
Max. Continuous Load Power ^②	5120W

① The maximum continuous current that the battery can withstand.

② The maximum continuous output power that the battery can support.

Internal Impedance	≤40mΩ
Battery Pack Case	Steel Plate Cold Common (SPCC)
Dimension	L18.9*W17.64*H6.3 inch
	L480*W450*H160 mm
Temperature Range	Charge: 0°C to 50°C / 32°F to 122°F
	Discharge: -20°C to 60°C / -4°F to 140°F
	Storage: -10°C to 50°C / 14°F to 122°F



THINGS TO KNOW BEFORE USING

Please take care to avoid metal or conductive objects touching the positive and negative terminals of the battery at the same time during your operation, otherwise it is likely to cause a short circuit.

DO NOT install the battery with the top or the post bolt facing down. If you are not sure about the installation direction, please contact us to confirm the direction.

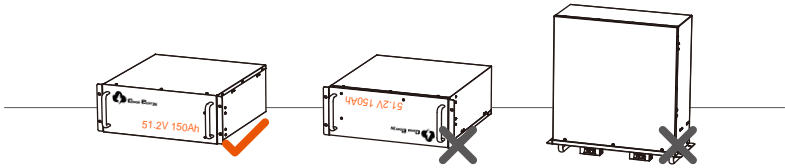

Tightly screw in the post bolts. Having loose battery terminals will cause the terminals to build up heat resulting in damage to the battery.

This battery is not intended to be used to start any devices, please **DO NOT use it as a starting battery.**

Suggestions for **Long-term Storage:**

○ Temperature

The battery can be operated at a temperature of -20°C to 60°C / -4°F to 140°F , and a temperature between **10°C to 35°C / 50°F to 95°F** is ideal for long-term storage. Store in a fireproof container and away from children.

○ Capacity

For a longer-lasting product, it is best to store your battery **at a 50% charge level** and recharge every three months if it is not going to be used for a long time.

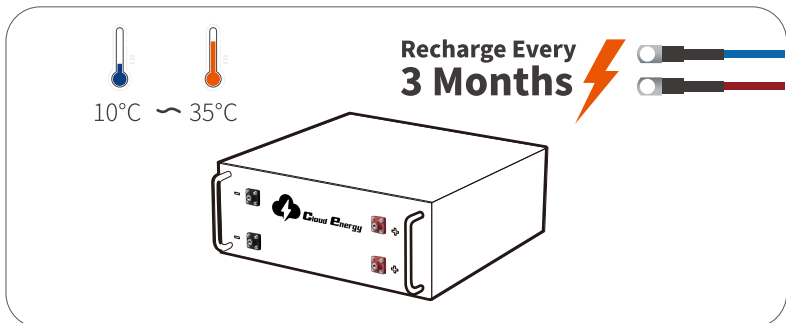

CHARGING METHODS

THE VOLTAGE WHEN CHARGING & DISCHARGING

Based on the characteristics of Lithium Iron Phosphate (LiFePO₄) batteries, the voltage measured by all LiFePO₄ batteries during charging/discharging is not the real voltage of the battery. Therefore, after charging/discharging and disconnecting the battery from the power source, the voltage of the battery will gradually drop/increase to its real voltage.

If you need to test the real voltage of the battery, please disconnect all the connections to the battery and test its voltage after putting it aside for over 30 mins.

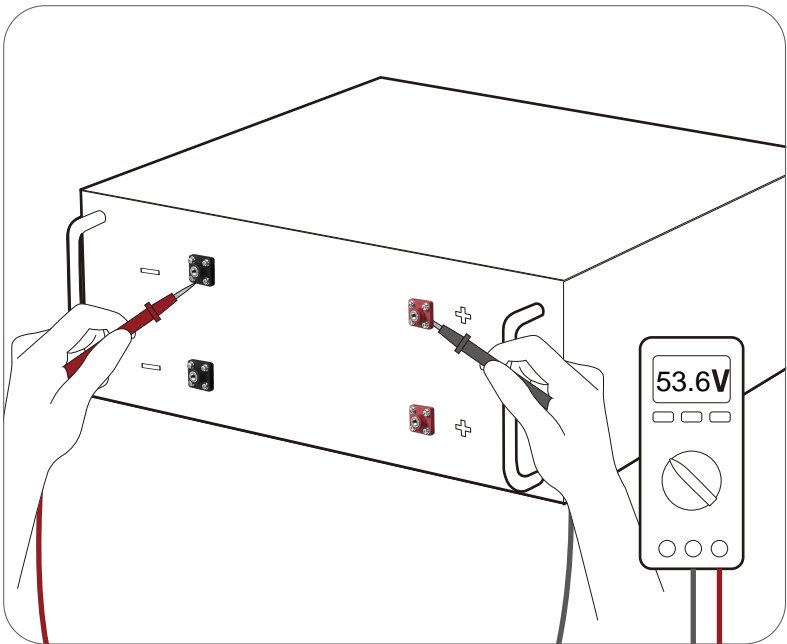

■ Tips When Testing The Battery Voltage by A Multimeter

- ① Put the red probe (+) tightly on the tightly screwed positive post bolt, and the black probe (-) on the tightly screwed negative post bolt.
- ② Do not touch the metal part of the probes with your hands during use.

BATTERY CHARGING LOGIC

The material characteristics of the LiFePO₄ battery determine that its charging curve is obviously different from that of a lead-acid battery.

Compared with a lead-acid battery, the LiFePO₄ battery has a simpler charging process and mode. Therefore, it is recommended to select LiFePO₄ for your charging mode.

If LiFePO₄ mode is not available, please refer to the recommended parameters on Page 07~08 for setting.

LiFePO₄ Battery Charging Mode

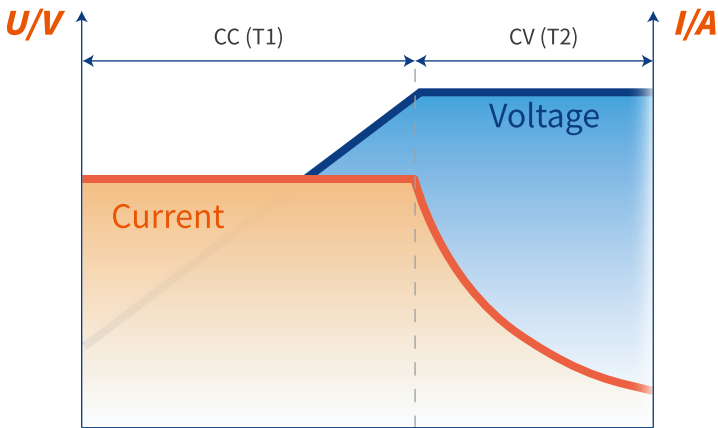

LiFePO₄ Battery Charging Curve

○ CC (Constant Current) Phase (T1)

In the beginning, a discharged battery will be charged with a constant current and voltage will be climbing steadily until reaching the constant voltage setpoint which varies for different charging methods.

○ CV (Constant Voltage) Phase (T2)

The battery maintains a constant voltage during this phase while the current gradually decreases to 2A (0.02C) which is also known as tail current^①. At this point, the charging is cut off and the battery is fully charged.

① Tail Current (A) = Battery Capacity * 0.02C. E.g., 100Ah*0.02C= 2A tail current.

Lead Acid Battery Charging Mode

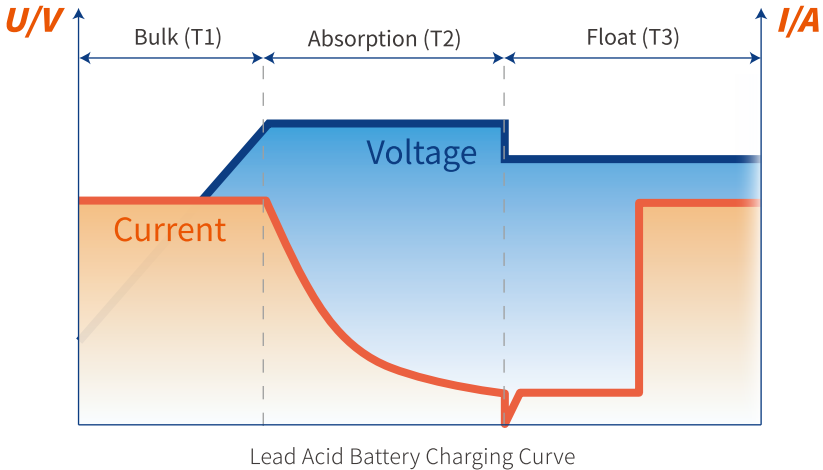

○ Bulk / Boost Phase (T1)

In the beginning, a discharged battery will be charged with maximum current and voltage will be climbing steadily until reaching the absorption voltage setpoint.

(This phase is basically equivalent to the CC phase of LiFePO₄ battery charging.)

○ Absorption Phase (T2)

The battery reaches the absorption voltage setpoint and holds the voltage constant while the current gradually decreases until the battery is becoming full (within 10-20%). Generally, absorption will not exceed 3 hours to prevent overcharging.

(This phase is basically equivalent to the CV phase of LiFePO₄ battery charging.)

○ Float Phase (T3)

After the absorption stage, the voltage of the battery will reduce to the float voltage setpoint and the current will also reduce to a low maintenance mode to prevent the battery from discharging and offsetting any self-discharge. Heavier battery discharge may set the controller back to Bulk/Boost or Absorption to replenish energy lost while energy is available.

(LiFePO₄ battery does not have this charging phase.)

SOLAR PANEL(S) & CONTROLLER

Solar Panel

☆ Recommend Power: $\geq 1500W$

- The battery can be fully charged in one day (with effective sunshine 4.5hrs/day) by 1500W solar panels.
- It may take more than one day to fully charge the battery by 1500W solar panels since the duration and intensity of light would be a great factor for their charging efficiency.

Controller

☆ Recommend Charging Current:

30A (0.2C)	The battery will be fully charged in around 5hrs to 100% capacity.
75A (0.5C)	The battery will be fully charged in around 2hrs to around 97% capacity.

☆ Recommend Charging Mode: **51.2 (58.4V) LI (LiFePO4)**

Controller Settings

Refer to the below parameters if you need to manually set up your controller. As different types of batteries have different charging modes (refer to Page 05-06), **it is recommended to set only the following parameters for LiFePO4 batteries.** The settings for other types of batteries do not apply to LiFePO4 batteries except for the following settings

CHARGING	Charge /Bulk /Boost Voltage	58.2V/ 58.4V
	Absorption Voltage	58.2V/ 58.4V
	Over Voltage Disconnect	59.2V
	Over Voltage Reconnect	54.4V
	Tail Current	2A (0.02C)
DIS-CHARGING	Under Voltage Warning	43.5V
	Under Voltage Recover	45V
	Low Voltage Disconnect	40.5V
	Low Voltage Reconnect	46.5V

BATTERY CHARGER

Use 54.75V lithium iron phosphate (LiFePO4) battery charger to maximize the capacity.

☆ Recommend Charging Voltage: Between 58.2V to 58.4V

☆ Recommend Charging Current:

30A (0.2C)	The battery will be fully charged in around 5hrs to 100% capacity.
75A (0.5C)	The battery will be fully charged in around 2hrs to around 97% capacity.

Tips

- ① Connect the charger to the battery before connecting it to the grid power in case of sparks.
- ② It's recommended to disconnect the charger from the battery after fully charging.

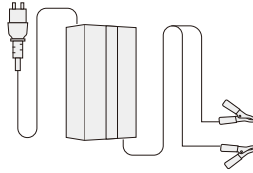

ALTERNATOR / GENERATOR

LiTime battery can be charged by an alternator or generator.

If the alternator/generator supports DC output, a DC-to-DC charger needs to be added between the battery and the generator; if the alternator/generator supports AC output, please refer to the recommendations in "Battery Charger" above to add a suitable battery charger between the battery and the generator.

☆ Recommend Charging Voltage: Between 53.25V to 54.75V

☆ Recommend Charging Current:

30A (0.2C)	The battery will be fully charged in around 5hrs to 100% capacity.
75A (0.5C)	The battery will be fully charged in around 2hrs to around 97% capacity.

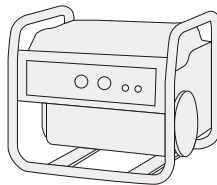

HOW TO ESTIMATE THE BATTERY CAPACITY

STATE OF CHARGE (SOC)

The battery capacity could be roughly estimated by its rest voltage (not charging/discharging voltage). As there are subtle differences in the voltage of each battery, the below parameters are for reference only.

Rest Voltage: The voltage needs to be tested at rest (with zero current) after 30 mins of disconnecting from the charger & loads.

CAPACITY	CHARGE VOLTAGE
100%	53.8V
99%	53V
90%	52.5V
70%	52V
40%	51V
30%	50V
20%	49V
10%	45V
1%	☆ 43V (recommend low voltage disconnect voltage)
0%	42V

PARALLEL CONNECTION

THE PREMISE OF CONNECTION

To connect in parallel, batteries should meet the below conditions:

- identical batteries with the same battery capacity (Ah) and BMS (A);
- from the same brand (as lithium battery from different brands has their special BMS);
- purchased in near time (within one month).

LIMITATION FOR SERIES/PARALLEL CONNECTION

Support connecting up to 16 identical batteries in parallel for up to: 48V 2400Ah battery system.

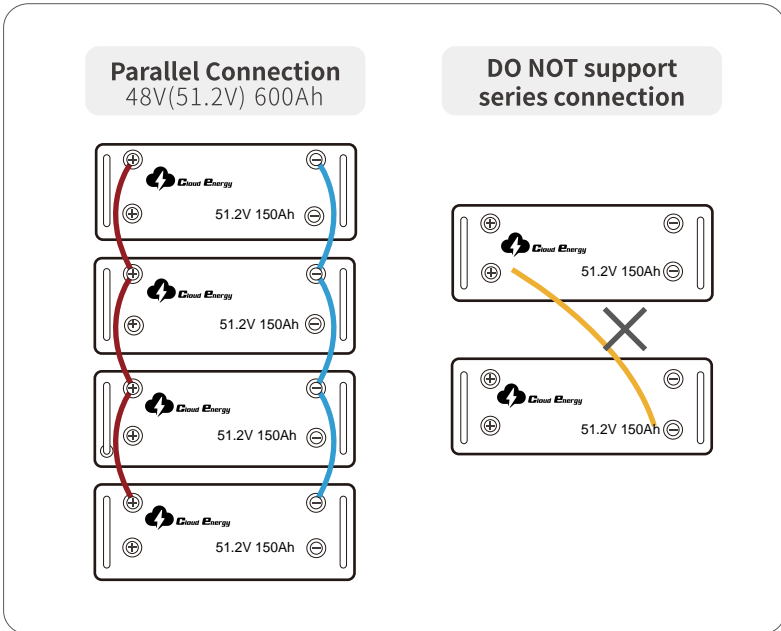

HOW TO CONNECT BATTERIES

Step1 Wear Insulating Gloves

Wear Insulating Gloves for protection before connecting. Please pay attention to operation safety in the process of connection.

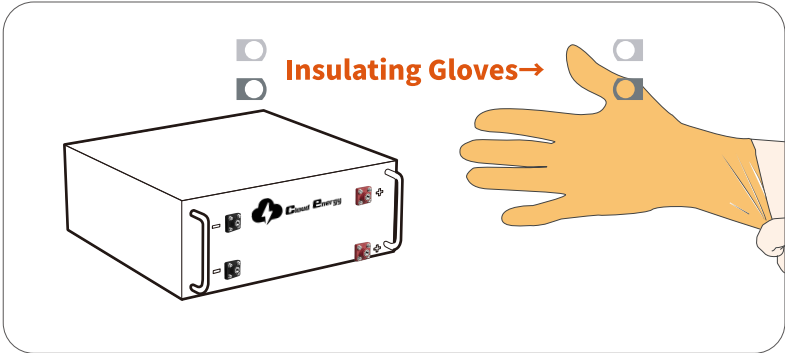

Step2 Voltage Balancing Before Connection

Below two steps are necessary to reduce the voltage difference between batteries and let the battery system perform the best of it in parallel.

Step **1** Fully charge the batteries separately.
(voltage at rest: $\geq 53.8V$)



Step
2

Connect the batteries one by one **in parallel**, and leave them together for **12~24hrs**. After the battery voltages have been balanced, the paralleled battery system can be connected to the load referring to Step 3 on Page 13.

Connect Batteries in Parallel **+** to **+** **-** to **-**

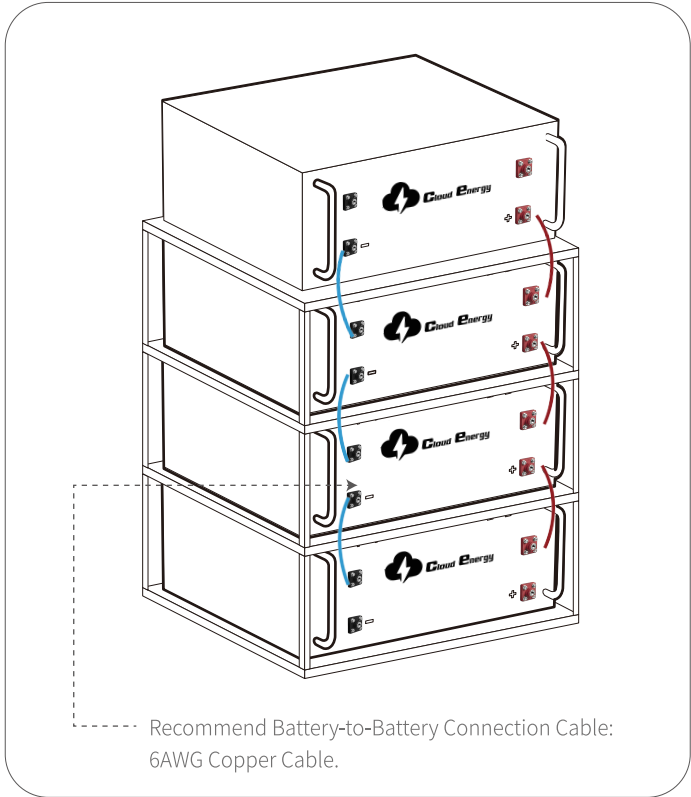

After parallel connection, the **capacity** of the battery system will be doubled according to the number of batteries you connect.

E.g. If two 48V 100Ah batteries are connected in parallel, the battery system will be 48V 200Ah.

Step 3 Total Input & Output Connection

Adding two copper bars^① to connect the paralleled system to the load.

Step
1

Connect all the positive output cables of the batteries to one copper bar.

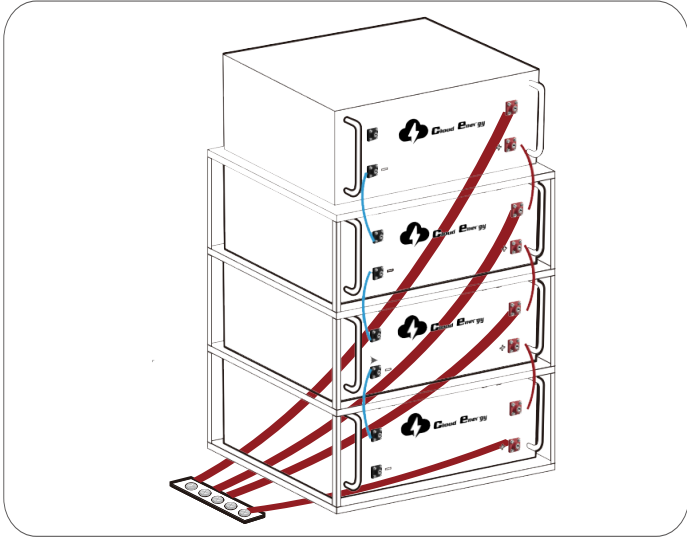

Step
2

Connect the **+** of the load to the copper bar. The cable gauge used in this step should be able to support the total input & output current of the entire battery system.

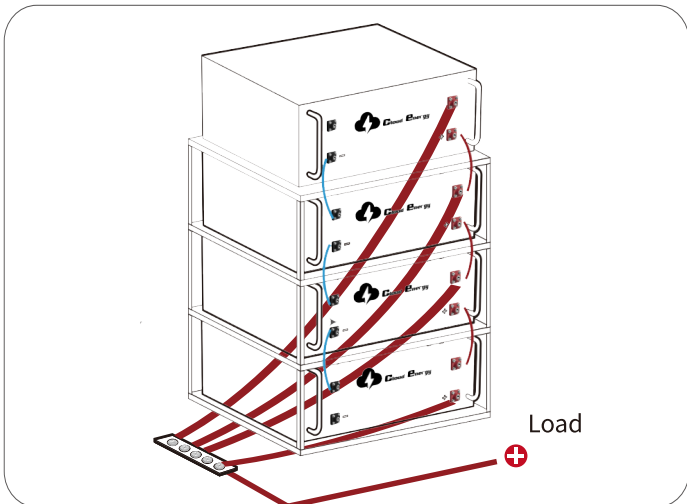

Step
3

The **⊖** of the battery system and load are also connected to another copper bar following the above steps.

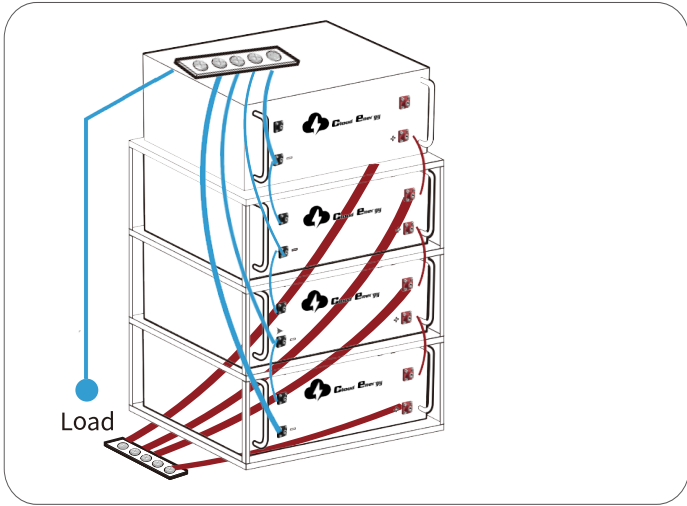

- ① Copper Bar: Flat metal made of copper. It can help ensure the input & output currents of each battery are balanced

Copper is recommended as it has better conductivity, and the conversion efficiency of the input & output currents for the battery will be higher.

Step 4 Rebalancing Every 6 Months

It is recommended to rebalance the battery voltage every six months following Step 2 on Page 11 if you're connecting multiple batteries as a battery system, as there might be voltage differences after six months of the battery system running.

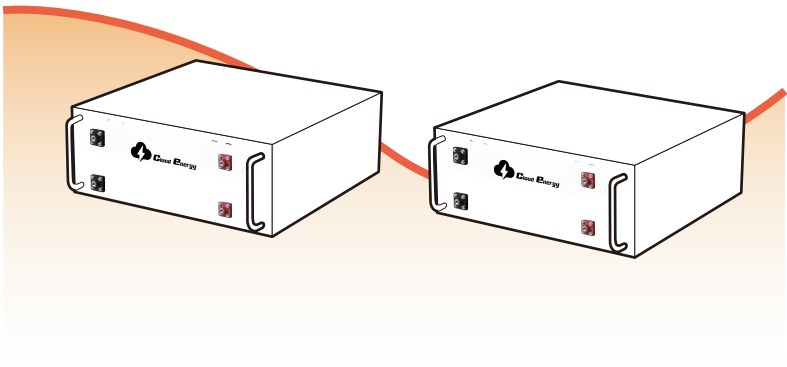

51.2V 600Ah Battery System:

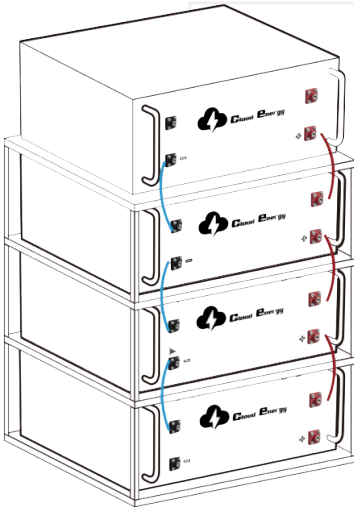

51.2V 600Ah Battery System

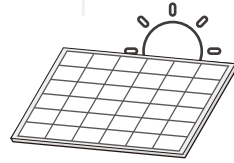

Solar Panels

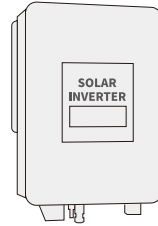

Solar Inverter



YARD LIGHT
(50W)



TV
(100W)



MICROWAVE OWEN
(800W)



COFFEE MACHINE
(1000W)



FRIDGE
(1200W)



WATER HEATER
(2000W)

↑ Various Loads
Supporting Max. 30,720 Load Power

INVERTER SETTINGS

METHOD ONE (RECOMMEND)

Select “[51.2\(58.4 V\) LI \(LiFePO4\) Mode](#)”

METHOD TWO

If method one is not available, select “User Mode” to enter values according to below parameters.

CHARGING	Charge Voltage	58.4 V
	Over Voltage Disconnect	59.2V
	Over Voltage Reconnect	54.4V

DIS-CHARGING	Under Voltage Warning	43.5V
	Under Voltage Recover	45V
	Low Voltage Disconnect	40.5V
	Low Voltage Reconnect	46.5V

The above setting parameters **apply to common inverters on the market** (such as Victron, Renogy, Growatt, Xantrex, Go Power, Lux Power, etc.). Different brands have slightly different descriptions or naming methods for each parameter. **Please directly set the parameters with the same meaning.**

If the inverter parameters to be set are special or cannot correspond to one of the above items, please contact info@cloudnewenergy.com for confirmation.

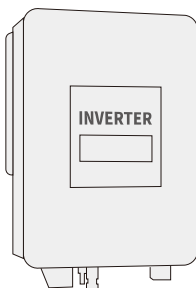

WHAT TO DO WHEN THE BATTERY STOPS WORKING?

When the battery

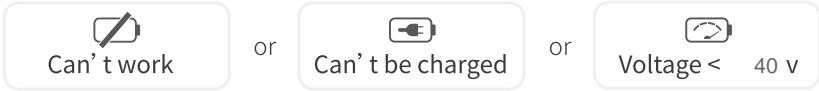

It has 85% chances that BMS has shut it off for protection, and you could try one of below ways to activate the battery.

GENERAL STEPS

If the BMS has cut off the battery for protection, follow the below steps to activate it.

Step
1

Cut off all the connections from the battery

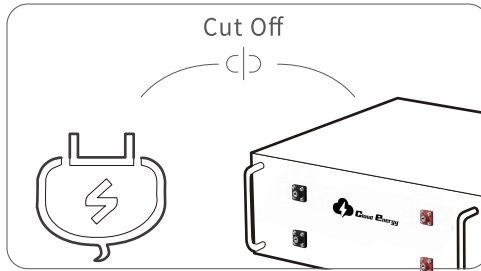

Step
2

Leave the battery aside for 30mins

Then the battery will automatically recover itself to normal voltage ($> 40\text{ V}$) and can be used after fully charged.

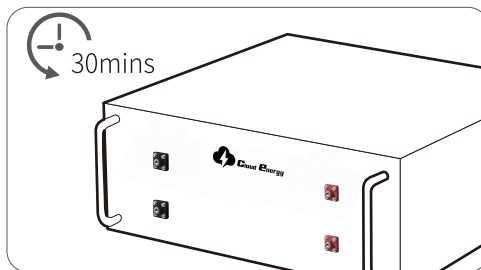

If the battery is unable to recover itself after the above steps, please try activating by **USING A CHARGER WITH A 0V CHARGING FUNCTION** ^① **TO FULLY CHARGE THE BATTERY.**

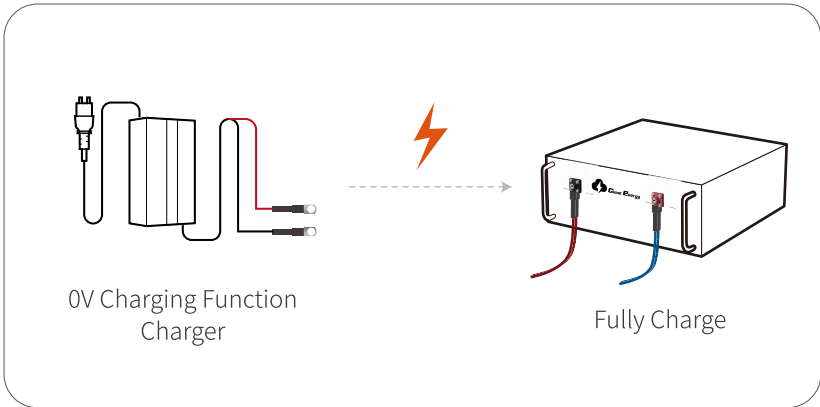

① The charger can charge the battery starting from 0V.

After activated (voltage > 37.5V) and fully charged by the normal charging method, it can be used normally.

ATTENTION

Caution: Risk of Fire, Explosion or Burns

DO NOT Short circuit

DO NOT Reverse connections from the charger to the battery

DO NOT Disassemble

DO NOT Throw into fire or incinerate

DO NOT Heat above 70°C / 158°F

WARNING

BATTERY DISPOSAL

The electrodes of the waste battery should be wrapped with insulating paper to prevent fire and explosion.

PROHIBITION OF DISASSEMBLY

Never disassemble the cells.

The disassembling may generate an internal short circuit in the cell, which may cause gassing, firing, explosion, or other problems.

The electrolyte is harmful.

Li-Fe battery should not have liquid from electrolyte flowing, but in case the electrolyte comes into contact with the skin, or eyes, physicians shall slush the electrolyte immediately with fresh water and medical advice is to be sought.

PROHIBITION OF DUMPING OF CELLS INTO WATER

Do not soak the battery in which the liquid, like water, seawater and non-alcoholic drinks, fruit juice, coffee or other drinks.

PROHIBITION OF DISASSEMBLY

If any abnormal features of the cells are found such as damages in a plastic envelope of the cell, deformation of the cell package, smelling of an electrolyte, an electrolyte leakage and others, the cells shall never be used anymore.

The cells with a smell of the electrolyte or a leakage shall be placed away from the fire to avoid firing or explosion.

PROHIBITION OF USING IN BELOW PLACES

Do not use the battery in a place with strong static electricity and a strong magnetic field, otherwise, it is easy to damage the battery safety protection device and bring hidden danger.

 www.cloudnewenergy.com

 info@cloudnewenergy.com